

PR-14

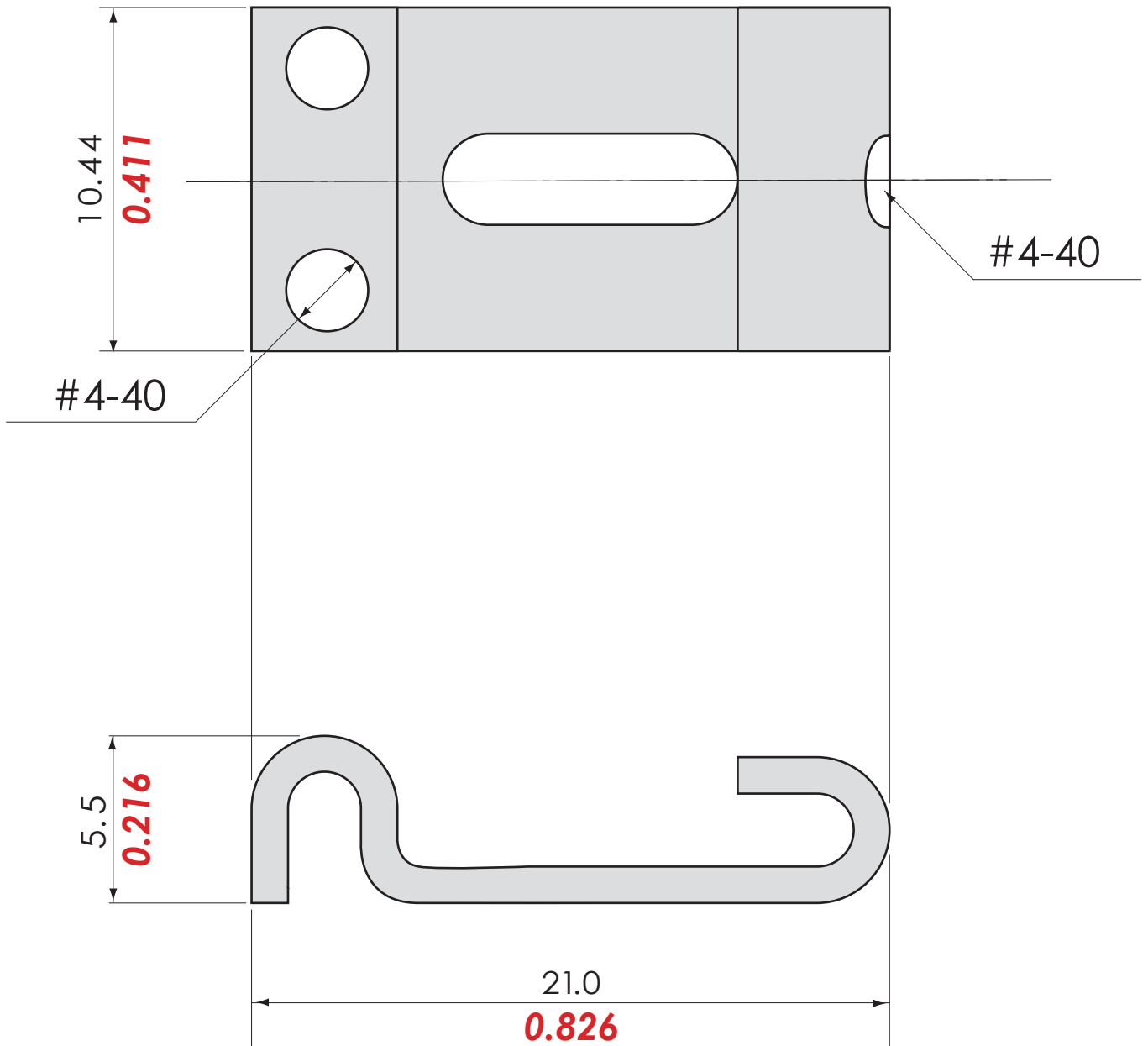

mm
inch

E to E = 52.5 mm
2¹/₁₆ inch